

J

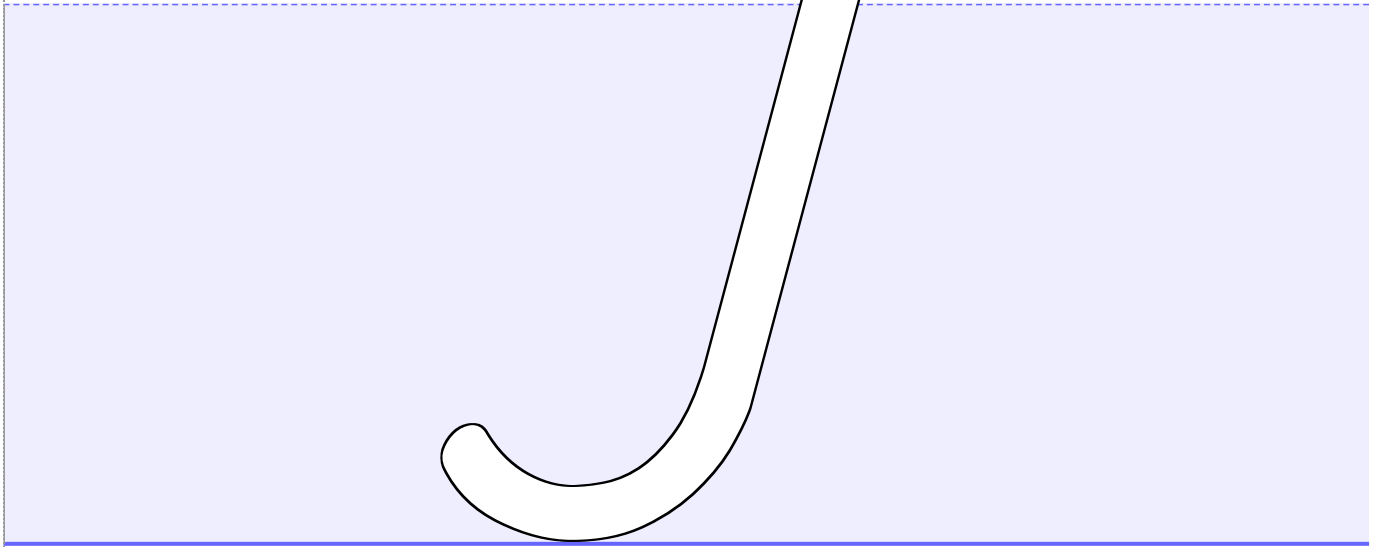

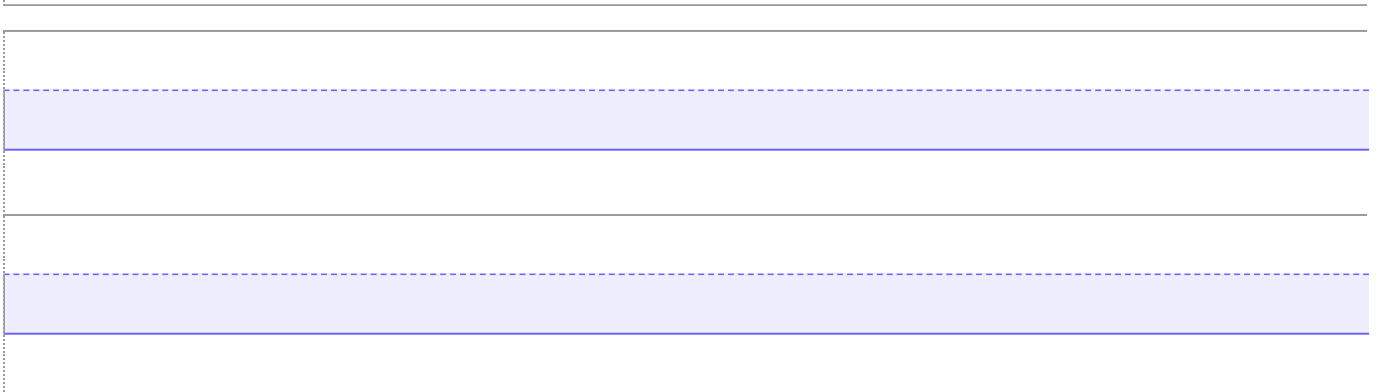

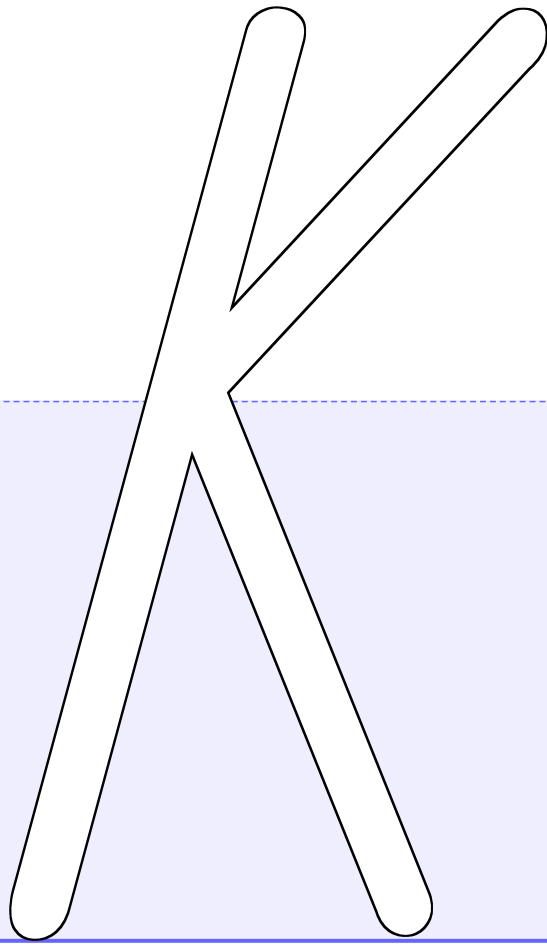

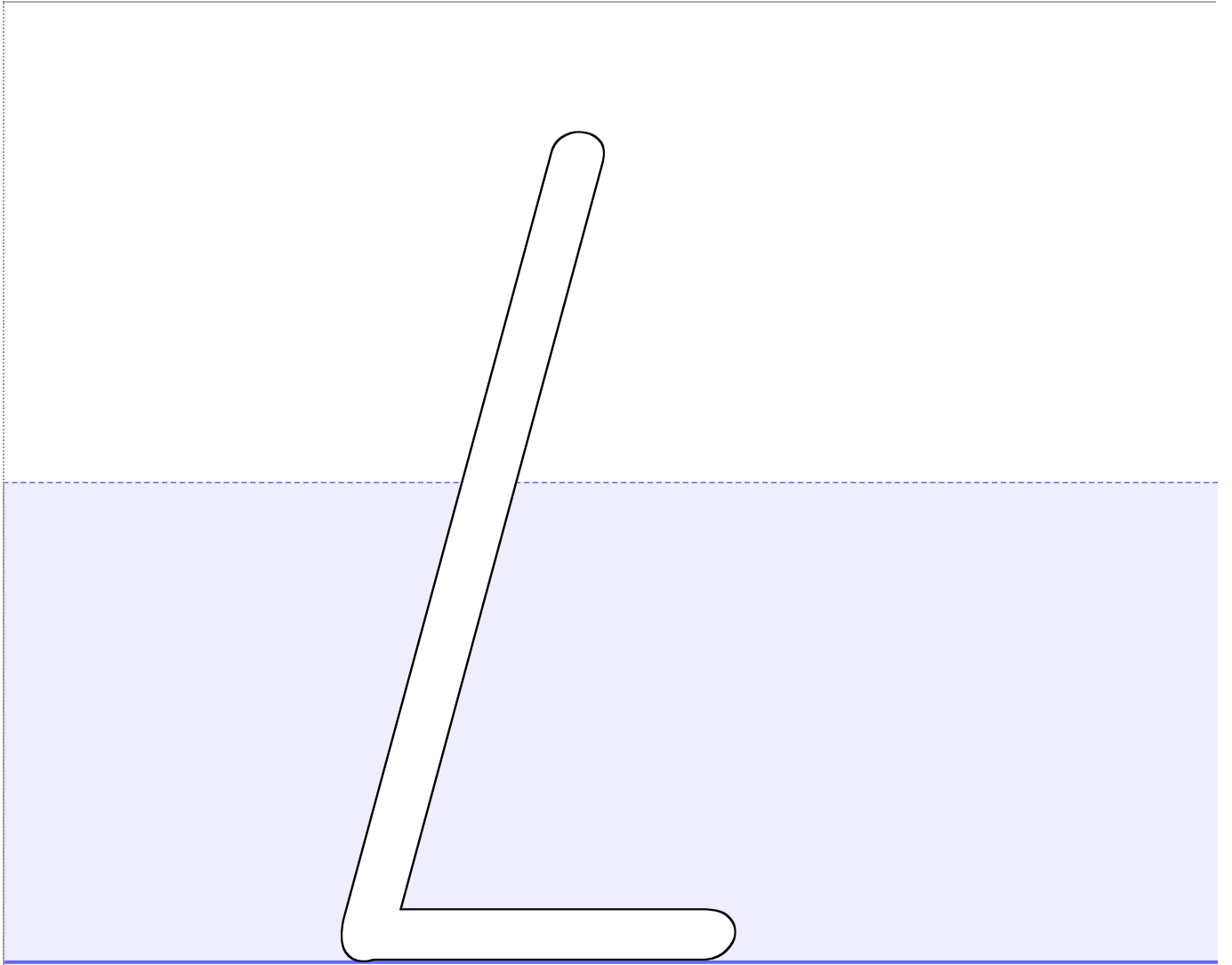
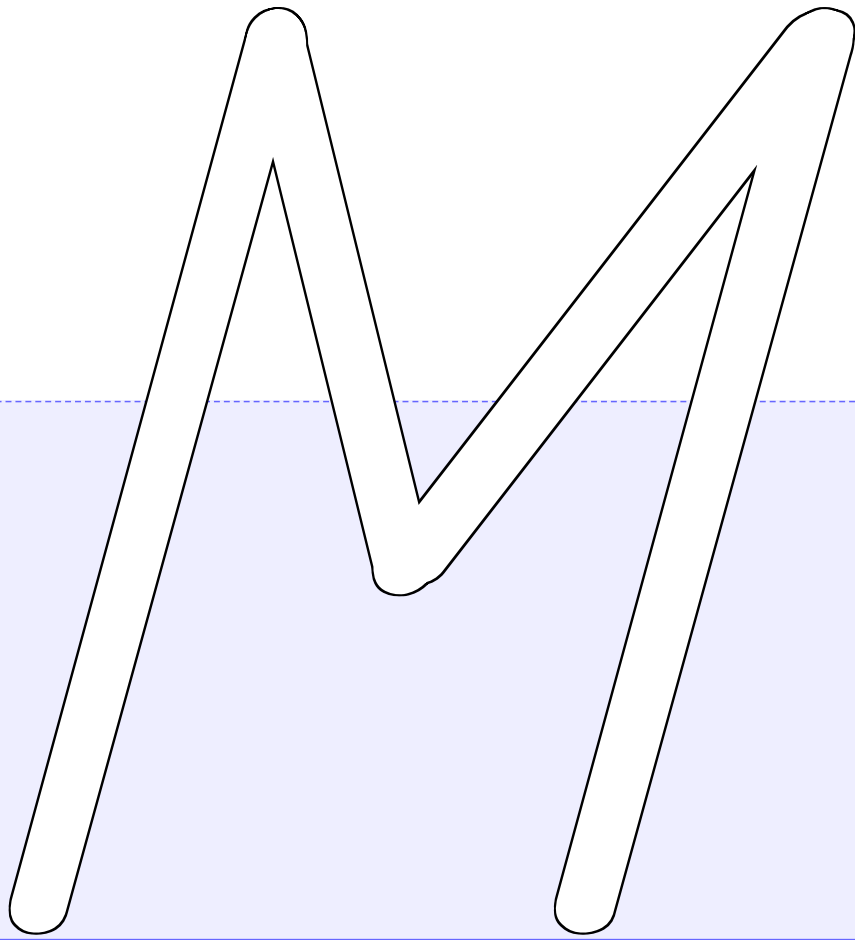

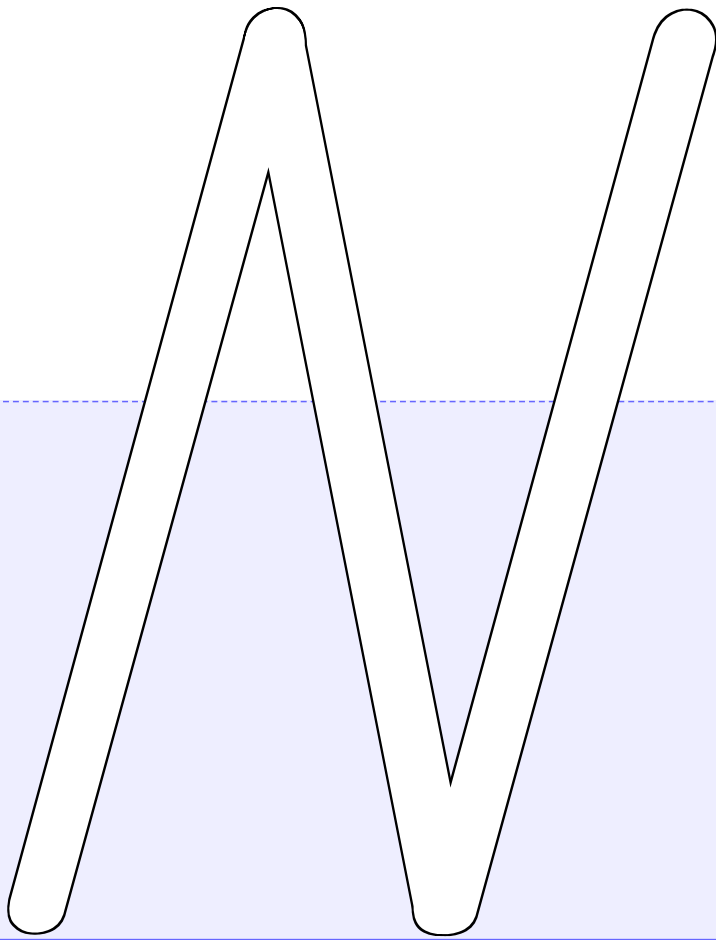

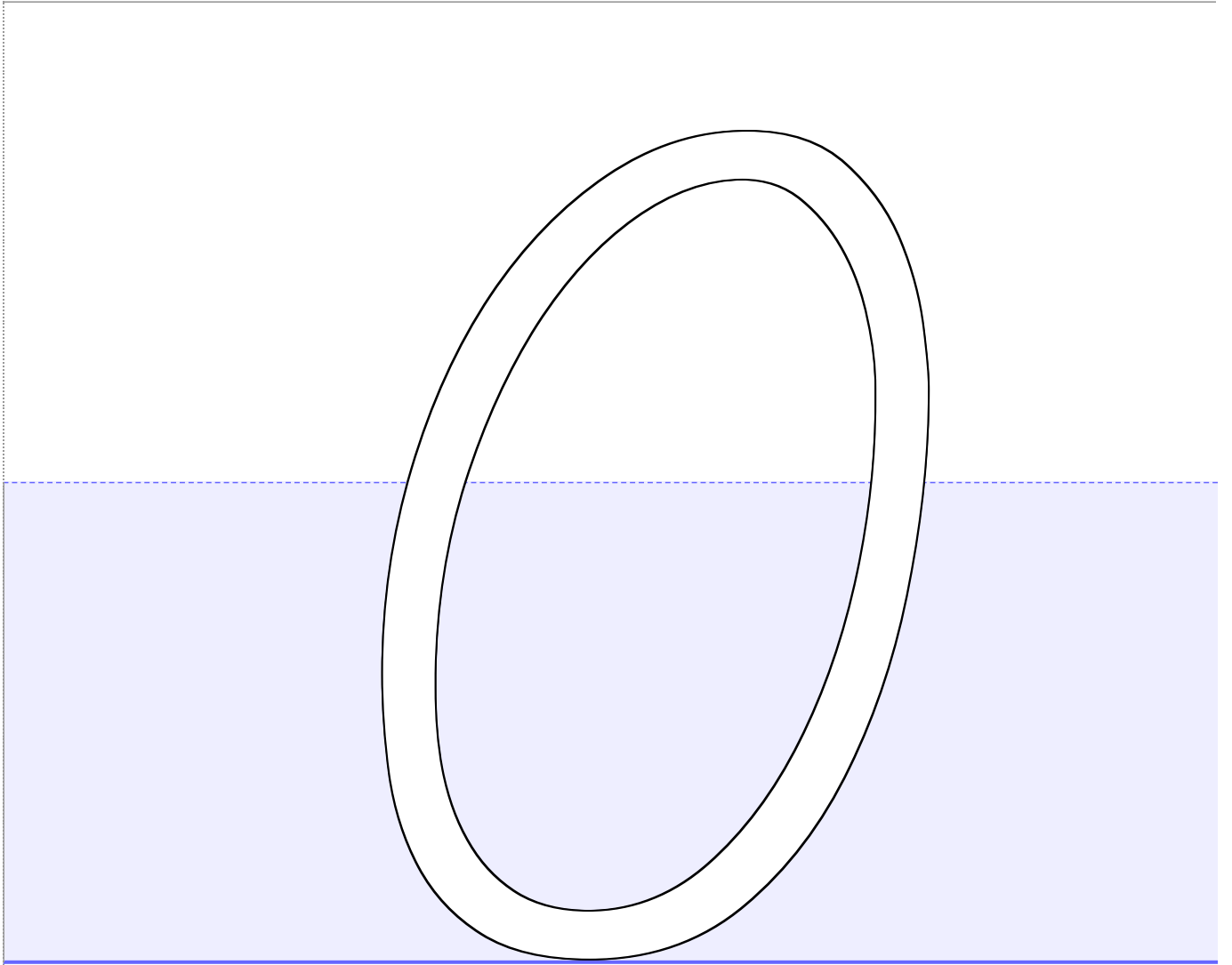

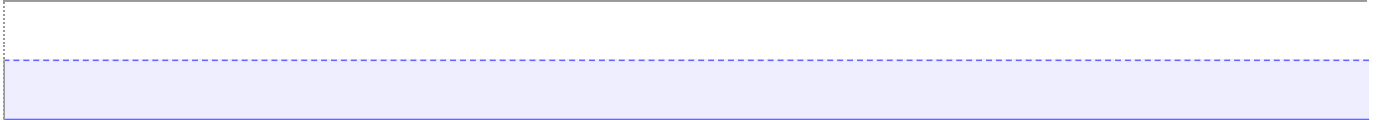
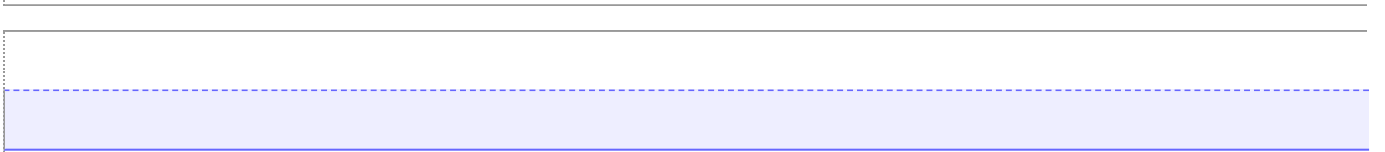
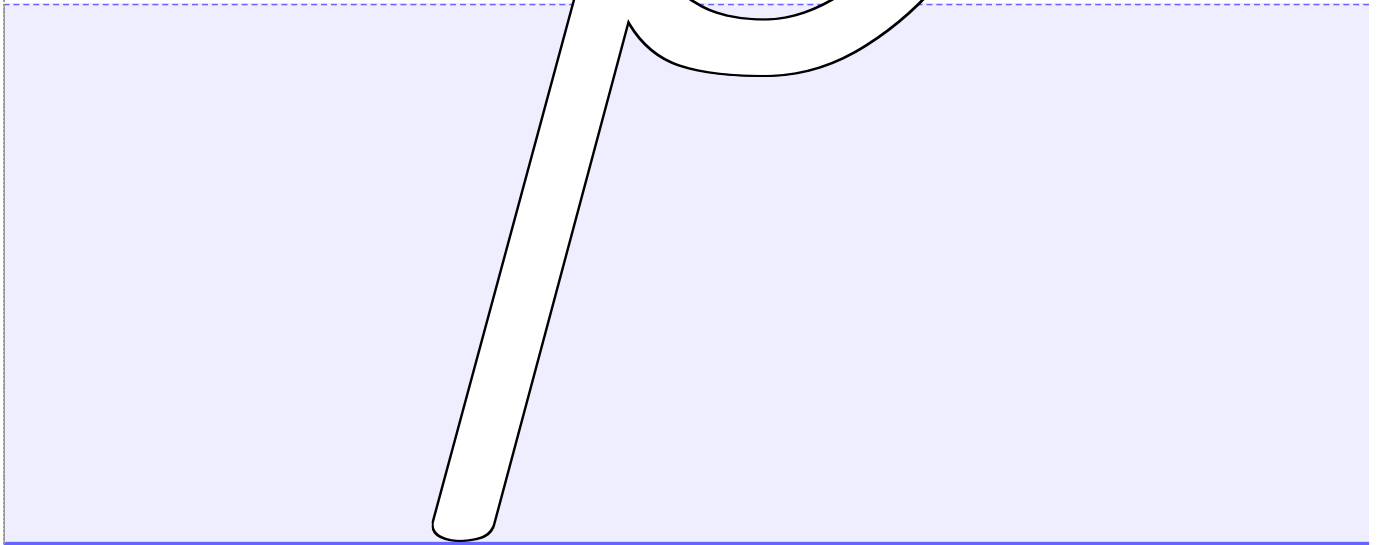
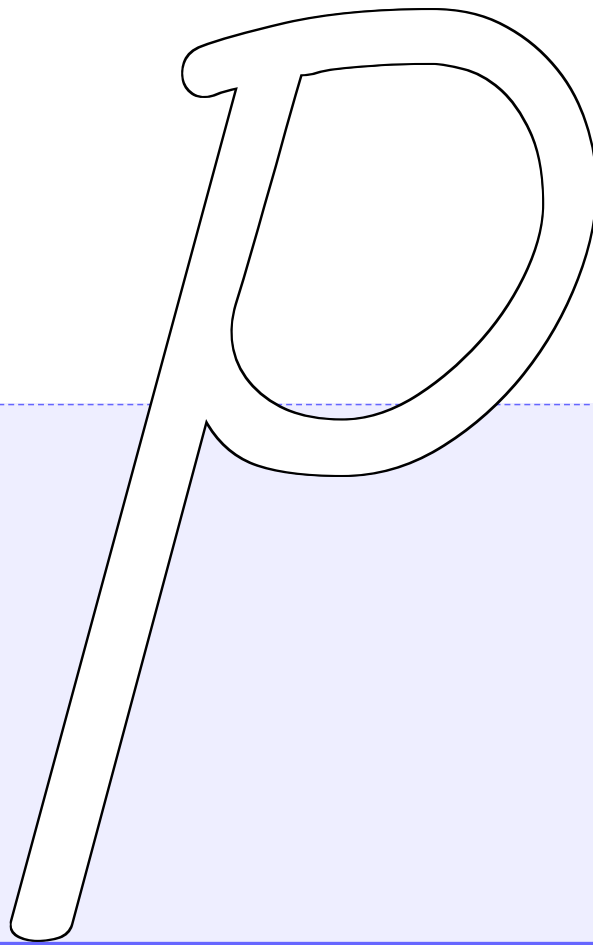



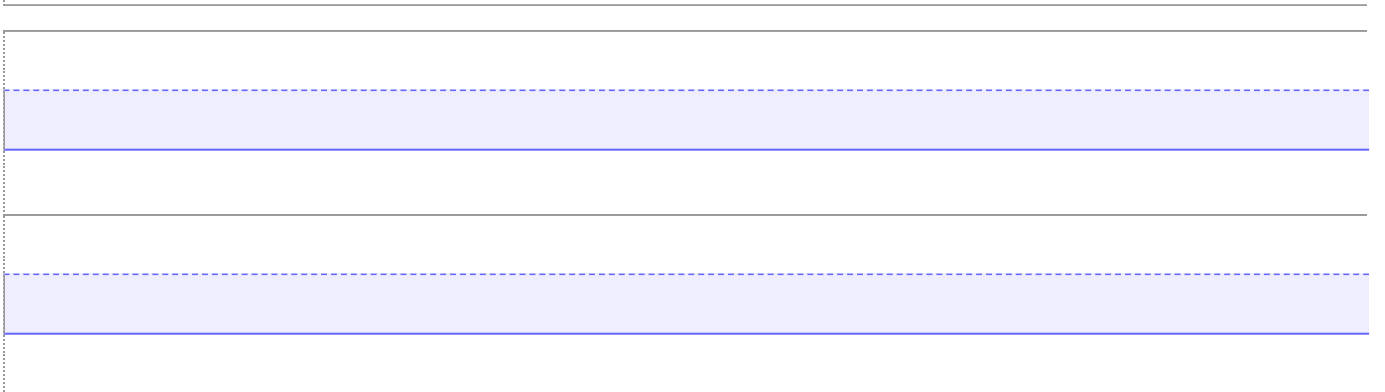
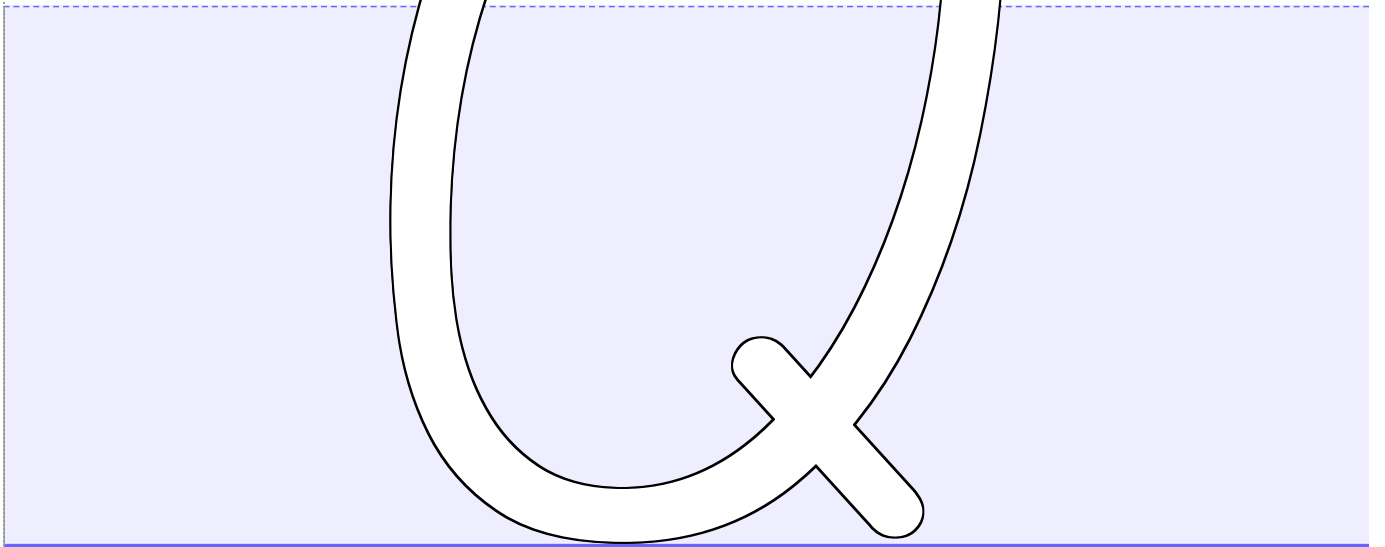
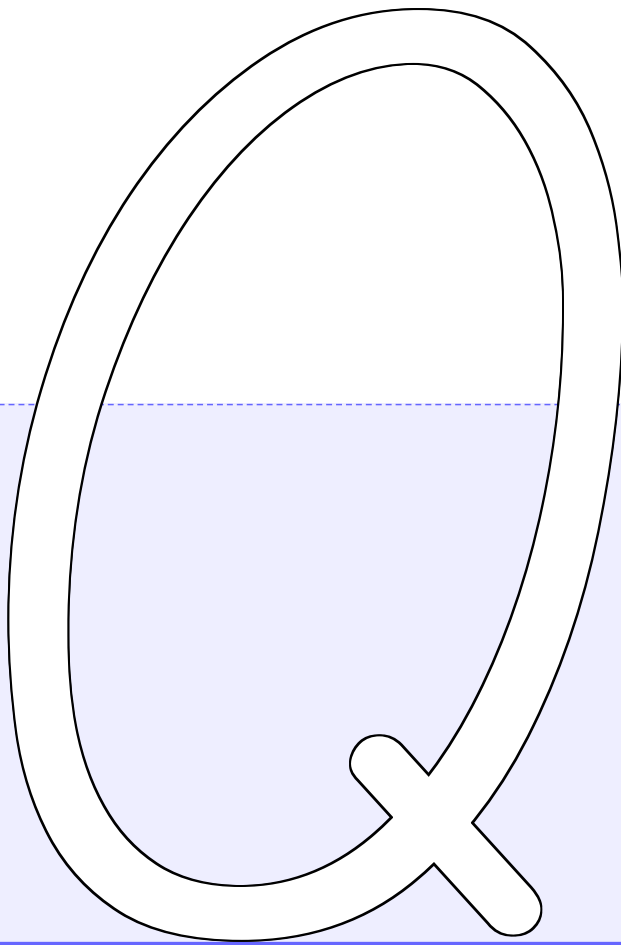

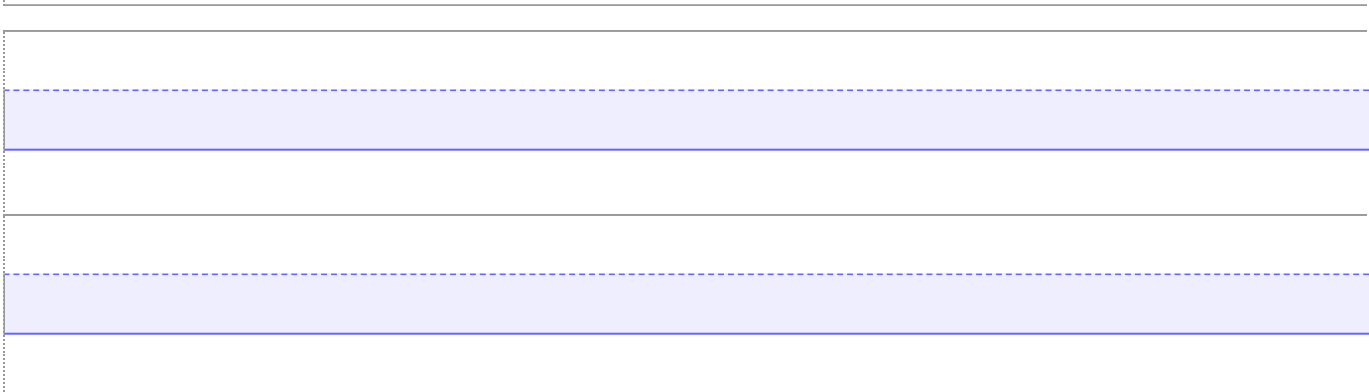
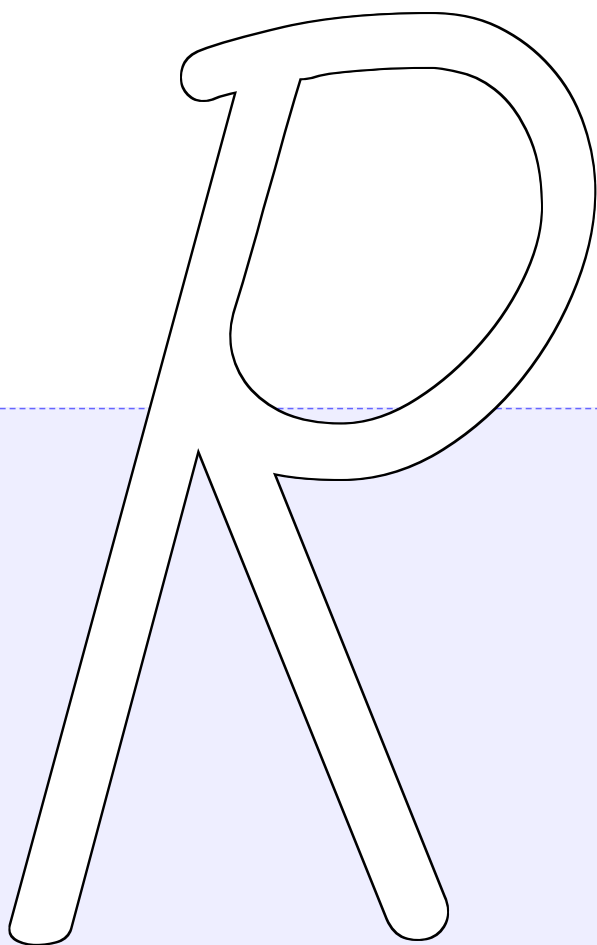

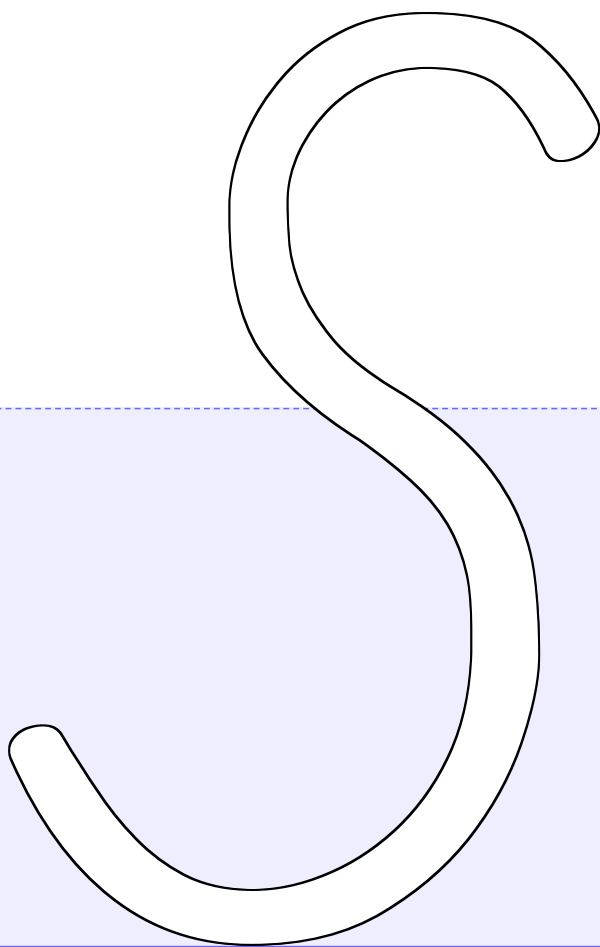

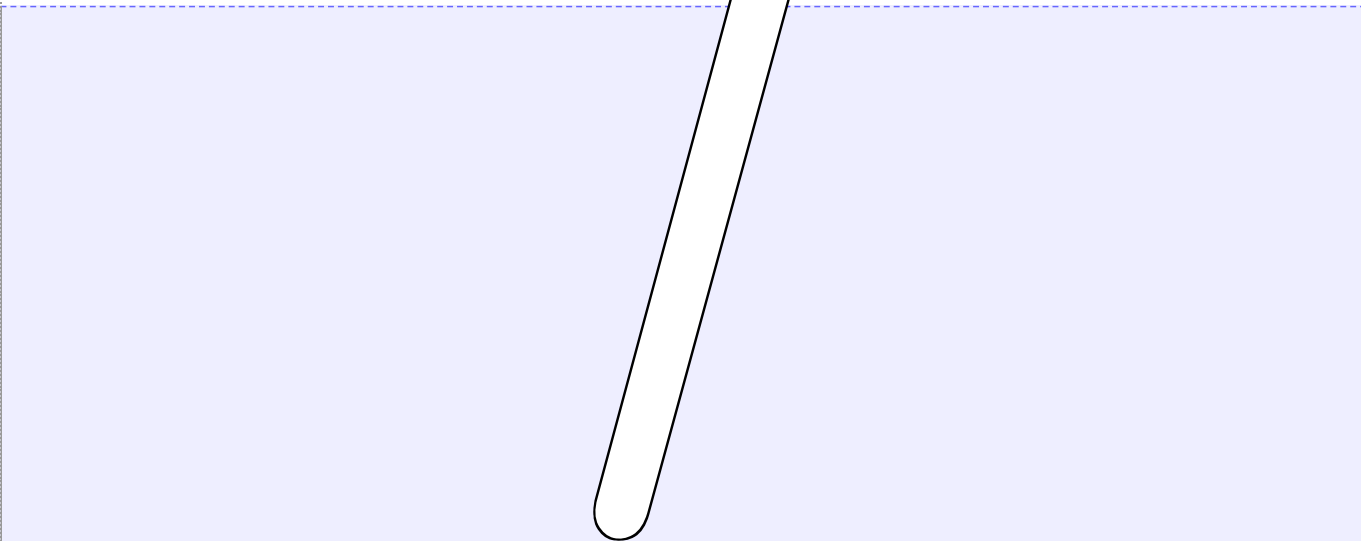
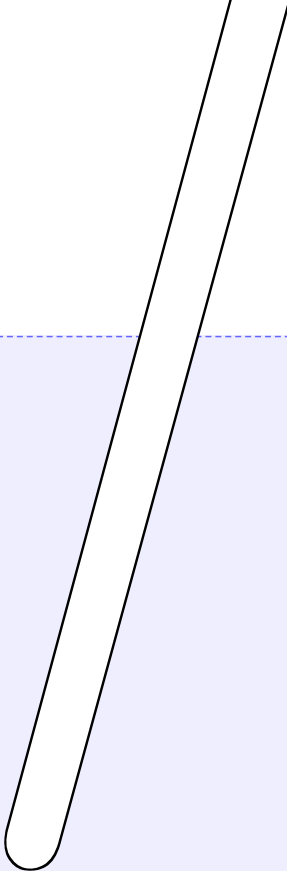
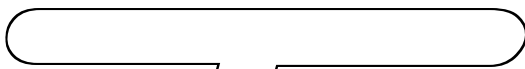

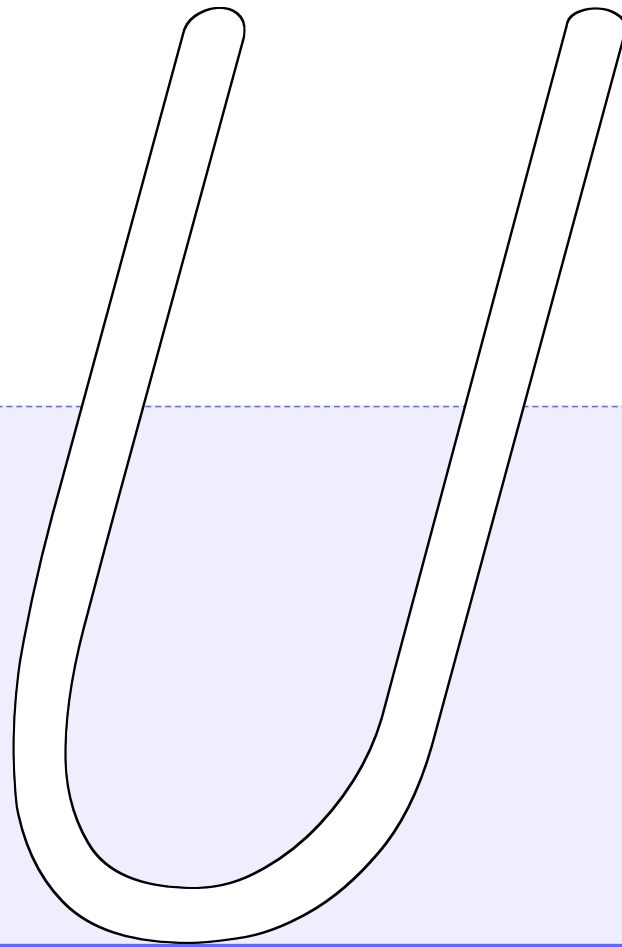

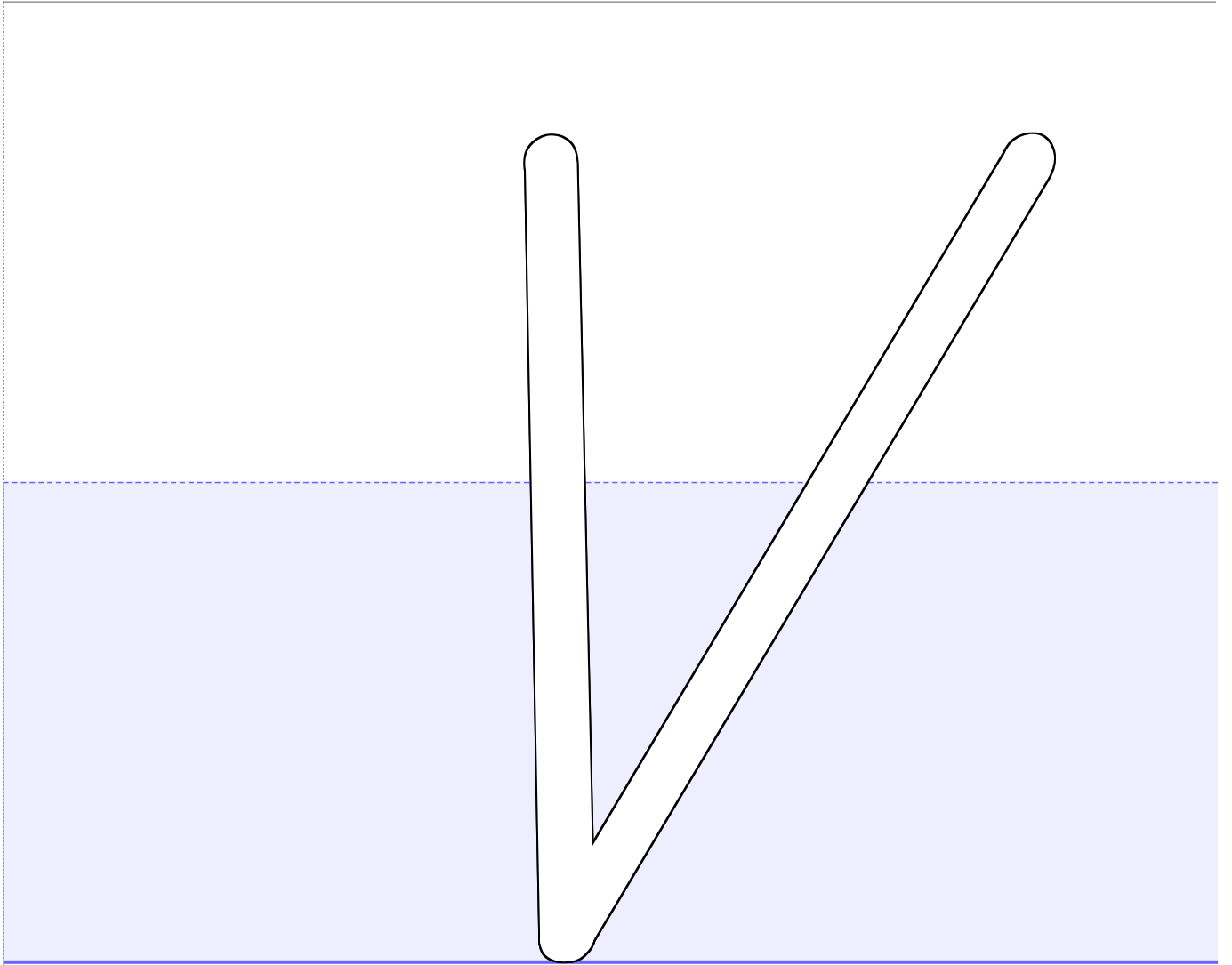

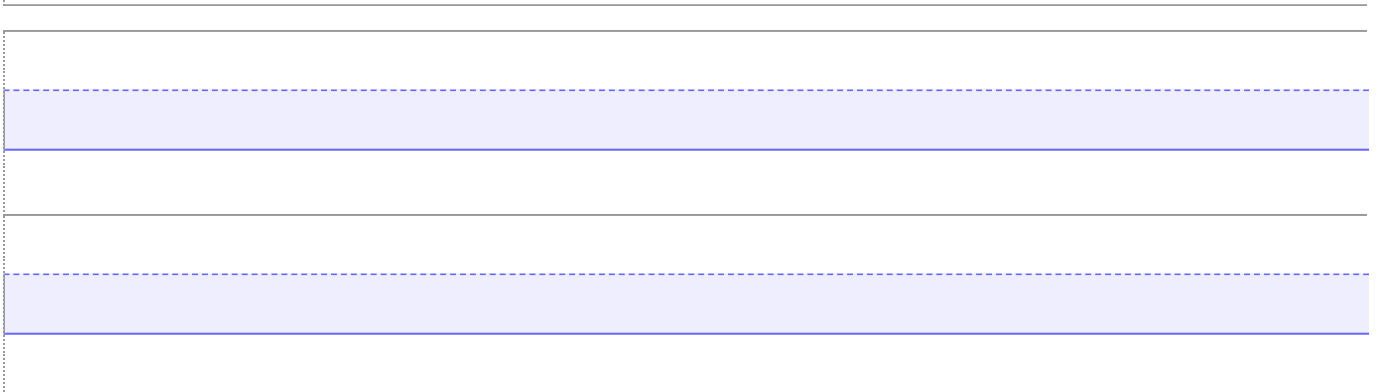
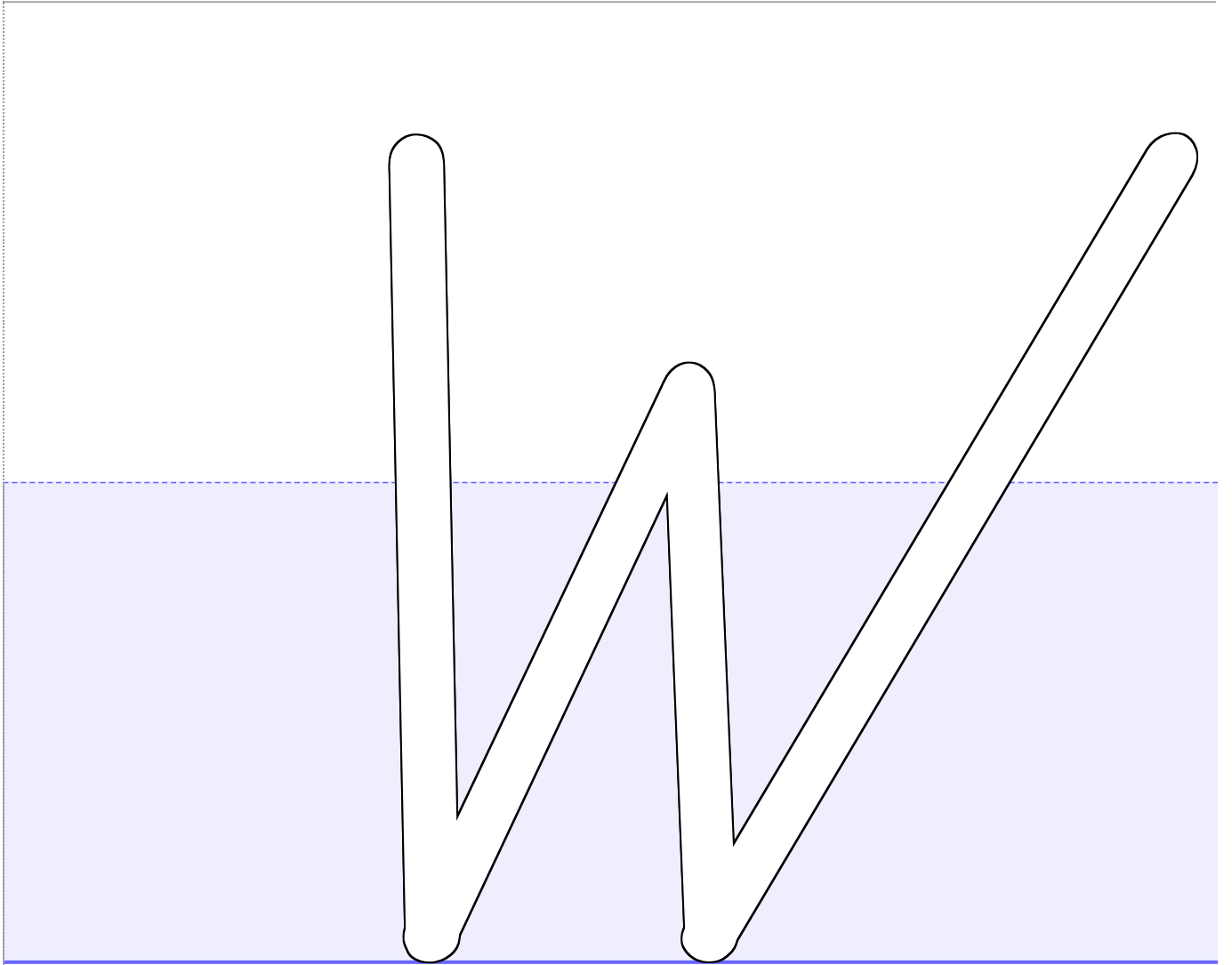

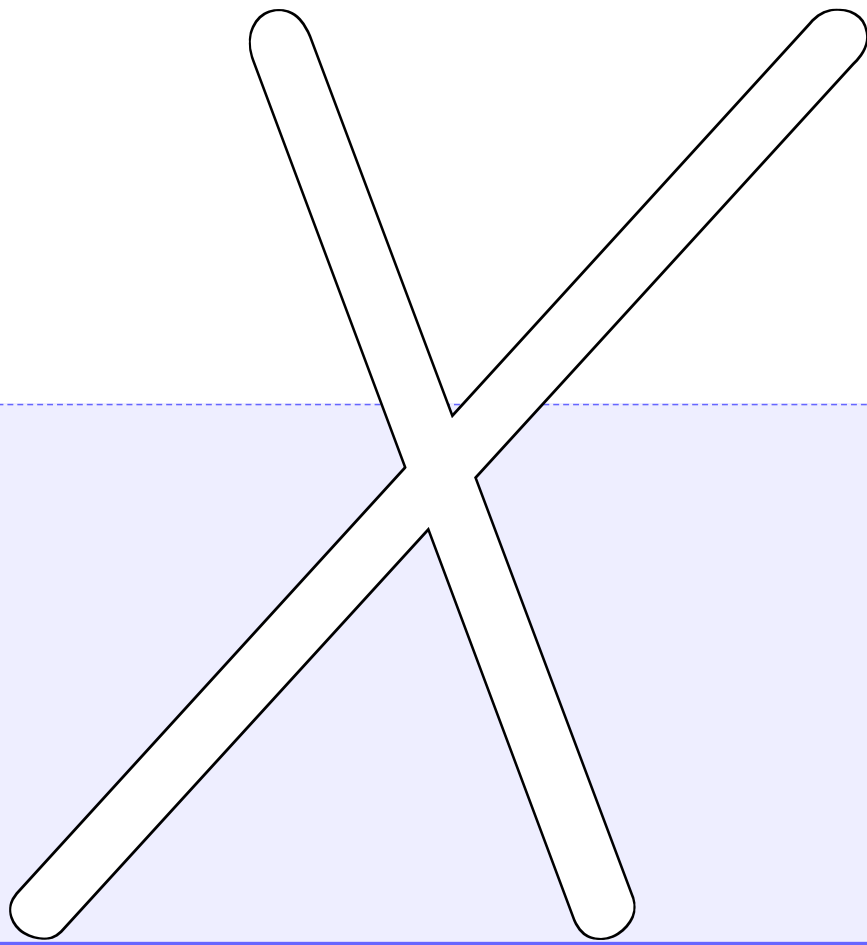

Two sets of handwriting practice lines. Each set consists of a solid top line, a dashed middle line, and a solid bottom line. The area between the dashed middle line and the solid bottom line is shaded light blue.



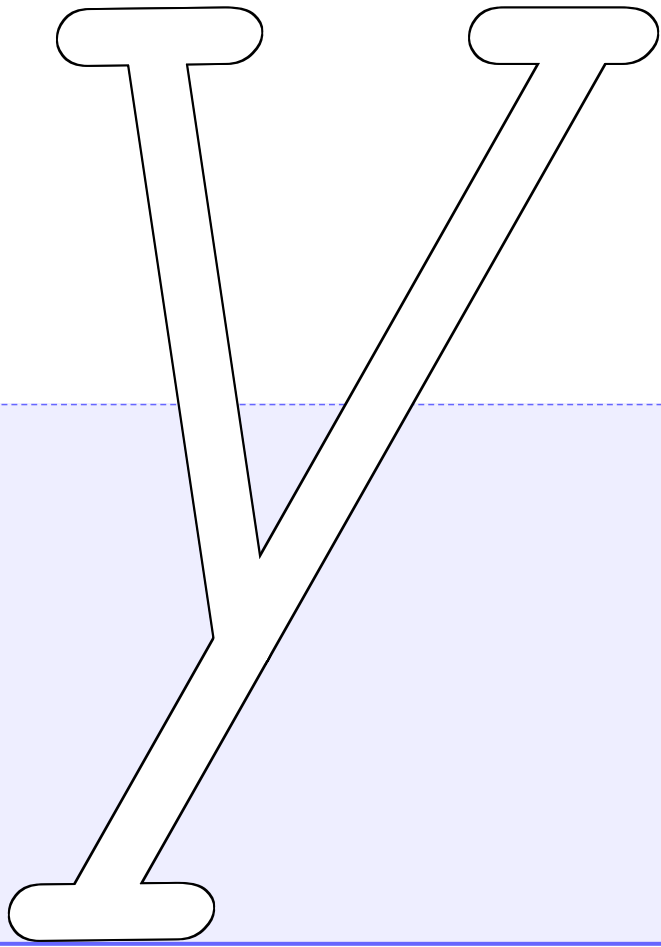

*I J*

